

Operating and installation instructions for washer-extractor PW 5105 Vario

To avoid the risk of accidents or damage to the machine it is **essential** to read these instructions before it is installed and used for the first time.

en - GB

M.-Nr. 07 968 150

Caring for the environment

Disposal of the packing material

The transport and protective packing has been selected from materials which are environmentally friendly for disposal and should be recycled.

Ensure that any plastic wrappings, bags, etc. are disposed of safely and kept out of the reach of babies and young children. Danger of suffocation.

Disposing of your old machine

Electrical and electronic machines often contain materials which, if handled or disposed of incorrectly could be potentially hazardous to human health and to the environment. They are, however, essential for the correct functioning of your machine. Please do not therefore dispose of it with your general waste.

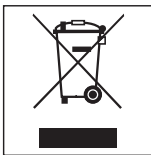

Please dispose of it at your local community waste collection/recycling centre or contact your dealer for advice. Ensure that it presents no danger to children while being stored for disposal.

Energy saving tips

Energy and water consumption

- Water consumption and energy usage are determined by the size of the load.
To make the most out of your machine load the maximum dry load for the programme you are using.

Detergent

- Do not exceed the amounts of detergent recommended by the manufacturer on the packaging.
- Reduce the amount of detergent for smaller loads.

When drying with a tumble dryer

Selecting the highest possible spin speed for the wash programme will save energy when drying in a tumble dryer afterwards.

Caring for the environment	2
Warning and Safety instructions	6
Operating the machine	11
Control panel	11
Before using for the first time	11
Display	12
Operating a wash-salon machine	14
Tips	15
1. Sort the laundry	15
2. Load the drum	16
3. Select a programme	16
Garment care label symbols	17
Short instructions	18
Selecting a programme	22
Selecting/changing a programme	22
Saving a favourite programme	24
Extras	25
Pre-wash	25
Starch stop	25
Rinse hold	26
Intensive*	26
Water plus*	26
Timer	27
Spinning	28
Maximum final spin speed	28
Rinse and interim spin	28
To omit the final spin (Rinse hold)	28
To omit the spin between rinses and the final spin	28

Contents

Changing the programme sequence	29
Payment system	29
Interrupting a programme	29
Cancelling a programme	29
Changing a programme	29
Detergent	30
Water softeners	30
Washing with several components	30
Colour run and dye removers/dyes	30
Fabric conditioners, liquid starch and starch formulations	31
Automatic dispensing of fabric conditioner or liquid starch to laundry at the end of a programme	31
Adding fabric conditioner or liquid starch separately	31
Adding starch separately	31
Adding starch separately using Starch stop	31
External dispensing system	32
Empty sensor	32
Cleaning and care	34
Cleaning the machine	34
Cleaning the water inlet filters	37
Problem solving guide	38
What to do if	38
The programme does not start	38
A fault message appears in the display	39
General problems	40
An unsatisfactory wash result	41
The door will not open	42
To continue a programme after a power cut	42
Opening the drum door in the event of a blocked drain outlet and/or power failure	43
Drain the machine	43
... Machines with a drain filter	43
Cleaning the drainage system	44
... Machines with a dump valve	44
Opening the drum door	45

After sales service	46
Repairs.	46
PC / Optical interface.	46
Optional accessories	46
Installation	47
Front view.	47
Rear view	48
Side view	49
Bird's eye view.	49
Installing the machine	49
Installation on a raised plinth	50
Payment system.	50
Installation surface.	51
Removing the transit bars	51
Re-fitting the transit bars	52
Levelling the machine	53
Plumbing	54
Connection to the cold water supply	54
Connection to the hot water supply	55
Recycled water connection	55
Connection to a very hot water supply	55
Water drainage	56
Dump valve version	56
Machines with a drain pump	56
Electrical connection	57
Technical data	58

Warning and Safety instructions

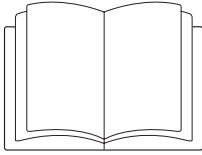

► It is **essential** to read these instructions.

This machine conforms to current safety requirements. Inappropriate use can, however, lead to personal injury and damage to property.

To avoid the risk of accidents and damage to the machine, please read these instructions carefully before using it for the first time. They contain important information on its safety, use and maintenance.

Keep these instructions in a safe place and ensure that they are made available to new users. They must be made aware of these warning and safety instructions.

Correct application

Only use the machine to wash items which are specified by the manufacturer to be machine-washable on the wash-care label, and textiles composed of hand-washable wool or wool blend fabrics as well as satin, lace, silk and other hand-washable garments. Any other applications may be dangerous. The manufacturer cannot be held liable for damage resulting from incorrect or improper use or operation of the machine.

► This machine must be used as described in these operating instructions and must be checked on a regular basis to make sure it is functioning correctly. Maintenance must be carried out when necessary.

► This machine is not intended for use by people with reduced physical, sensory or mental capabilities, or lack of experience or knowledge, unless they have been shown how to use it correctly by a person responsible for their safety.

► Keep children away from the machine at all times. It is not a toy! To avoid the risk of injury do not allow children to play on or near it or to play with its controls. Supervise its use by the elderly or infirm, and supervise children whilst you are using it.

► It is the operator's responsibility to ensure that the standard of disinfection in thermal as well as chemo thermal procedures is maintained (in accordance with local authority regulations) by carrying out suitable validation tests. Disinfection programmes must not be interrupted, as this can have a limiting effect on the disinfection result.

► If the machine is used in a publically accessible room, it is the supervisor's responsibility to ensure that suitable measures are in place which enable operators to use it safely.

Warning and Safety instructions

Technical safety

► Before setting up the machine, check it for any externally visible damage.

Do not install or use a damaged machine.

► The electrical safety of this machine can only be guaranteed when it correctly earthed. It is most important that this basic safety requirement is observed and regularly tested, and where there is any doubt the on-site wiring system should be inspected by a qualified electrician. The manufacturer cannot be held liable for the consequences of an inadequate earthing system (e.g. electric shock).

► Unauthorised repairs could result in unforeseen dangers for the user, for which Miele cannot accept liability. Repairs should only be undertaken by a Miele approved service technician. If this is not done any resultant damage will not be covered by the guarantee. Ensure current is not supplied to the machine until after maintenance or repair work has been carried out.

► Do not make any alterations to the machine, unless authorised to do so by Miele.

► In the event of a fault or for cleaning purposes, the machine must be disconnected from the electricity supply.

- it is switched off at the wall socket and the plug is withdrawn, or
- it is switched off at the mains, or
- the screw-out fuse is removed (in countries where this is applicable).

► This machine must only be connected to the on-site water supply using a hose that is in good condition. Old hoses must not be re-used. Check the hose regularly for signs of wear. Change in good time to avoid the risk of leaks and subsequent damage.

► Faulty components must only be replaced by genuine Miele original spare parts. Only when these parts are fitted can the safety standards of the machine be guaranteed.

► **Do not** use force to open the drum door. The door handle is fitted with a safety device to ensure that the door lock functions correctly.

Warning and Safety instructions

▶ If this machine is being used in a commercial environment please ensure that all relevant health and safety regulations are obeyed.

▶ This machine may only be used in mobile installations such as ships, if a risk assessment of the installation has been carried out by a suitably qualified engineer.

▶ In areas which may be subject to infestation by cockroaches or other vermin, pay particular attention to keeping the machine and its surroundings in a clean condition at all times. Any damage which may be caused by cockroaches or other vermin will not be covered by the guarantee.

Correct use

▶ Do not install your machine in rooms where temperatures below freezing may occur. Frozen hoses may burst or split. The reliability of the electronic control unit may be impaired at temperatures below freezing point.

▶ Before using the machine for the first time, check that the transit bars at the rear of the machine have been removed (see section on "Installation"). During spinning, a transit bar which is still in place may result in damage to both the machine and adjacent furniture or appliances.

▶ Turn off the stopcock if the machine is to be left for any length of time (e.g. holiday), especially if there is no floor drain (gully) in the immediate vicinity.

▶ Flooding danger.

If hooking the drain hose into a wash basin, check that the water can drain off quickly enough to prevent the sink from overflowing. Make sure the drain hose is secure, so that the force of the water flowing out of the hose does not dislodge it.

▶ Take care to ensure that foreign objects (e.g. nails, pins, coins, paper clips) do not find their way into the machine with the laundry. Shake out wash cloths before placing them in the machine to ensure that any coarse or harmful residues are removed. These may damage components of the machine (e.g. suds container, drum), which in turn can result in damage to the laundry.

▶ If the correct amount of detergent is dispensed, the machine should not need to be descaled. If, however, you do wish to descale the machine only use proprietary non-corrosive descaling agents and strictly observe the instructions on the packaging. A special descaling agent is available to order from the Miele Spare Parts Department or your Miele dealer.

Warning and Safety instructions

▶ Textiles which have been pre-treated in solvent based cleaning agents must be thoroughly rinsed in clean water before being washed in this machine.

▶ Never use solvent based cleaning agents in this machine, as this may result in damage to component parts and create toxic fumes. Such agents also pose a fire and explosion hazard.

▶ Benzene, petrol, paraffin or any easily flammable liquid must not be stored or used near this machine. Fire and explosion risk!

▶ Only use dyes specified by the manufacturer as being suitable for use in a washing machine. Always observe the manufacturer's instructions carefully.

▶ Colour run and dye removers contain sulphur compounds which can cause damage such as corrosion. Do not use these products in this machine.

▶ Avoid contact of stainless steel surfaces (front, lid, casing) with liquid cleaning and disinfecting agents which contain chlorine or sodium hypochlorite. These agents can have a corrosive effect on stainless steel. Aggressive vapours containing chlorine bleach can also be corrosive. Do not store open containers of these agents near the machine.

▶ Do not use a pressure washer or hose to clean the machine.

▶ It is particularly important to observe manufacturer's instructions when using a combination of cleaning agents and special application products. Products must only be used for applications approved by the manufacturer to avoid any material damage or the occurrence of strong chemical reactions.

Chlorine and component damage

Notes on using chlorine bleach and perchlorethylene

▶ Frequent use of chlorine increases the risk of component damage.

The use of agents containing chlorine, such as sodium hypochlorite and chlorine bleach in powder form, can damage the protective upper surface of stainless steel and cause corrosion to components. Factors affecting this are chlorine concentration levels, contact time and temperature. It is therefore advisable to avoid the use of such agents. Oxygen based bleaching agents should be used instead.

If, however, chlorine based bleaching agents have to be used for particular types of soiling, then anti-chlorine measures must also be carried out. If this is not done irreparable damage can occur to components in the machine and to laundry.

Warning and Safety instructions

Anti-chlorine treatment

Anti-chlorine treatment has to be carried out immediately after chlorine bleach has been used. The use of hydrogen peroxide or an oxygen based cleaning or bleaching agent is recommended and the laundry should not be drained in between.

With thiosulfate, especially when used with hard water, gypsum can form, which can lead to incrustations on laundry or deposits in the machine. The use of hydrogen peroxide is preferable as it aids the chlorine neutralising process.

The exact quantity of additives and the treatment temperatures required must be set and tested on site in accordance with the dosage recommendations of the detergent and additive manufacturers. The laundry must also be tested to check whether it contains any active chlorine residues.

Accessories

▶ Accessory parts may only be fitted when expressly approved by Miele. If other parts are used, guarantee, performance and product liability claims will be invalidated.

Disposing of your old machine

▶ Before disposing of an old machine it is important to disable the door lock. This way you will prevent the risk of children accidentally locking themselves in and endangering their lives.

Miele cannot be held liable for damage caused by non-compliance with these Warning and Safety instructions.

Control panel

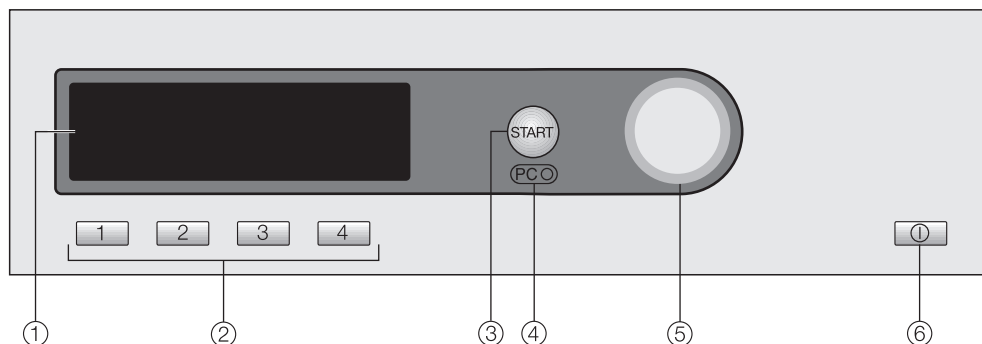

① **Display**

See the following pages for more information.

② **Short cut buttons**

For selecting an individual programme quickly. These buttons can be re-programmed to select your favourite wash programmes instead of the pre-set ones.

③ **Start button**

④ **PC / Optical interface**

This is used by service technicians for testing purposes and for uploading new software to the machine.

⑤ **Multi-function selector**

This is used to select menu options (by turning it) and to confirm your selection (by pressing it).

⑥ **On-Off button** ⓪

Before using for the first time

Before using the machine for the first time ensure that it is correctly installed and connected. See "Installation". Also check that the drain filter is securely tightened to prevent the risk of water leaks during use.

Commission the machine as described in the separate booklet supplied with the machine.

Display

Entry menu

1	Cottons Uni.	60°C	Programme selection...
2	Minimum iron	40°C	Settings ↗...
3	Delicates	40°C	
4	Woollens ↶	30°C	10:00

When the machine is switched on, the entry menu (with four favourite programmes listed) appears and *Programme selection* is highlighted.

Multi-function selector

Turning the multi-function selector moves the highlighting to the next option.

Pressing the multi-function selector selects the highlighted option.

Short cut buttons

Pressing a short cut button selects one of the four favourite programmes shown on the left of the display.

If you wish to change the programmes shown in this list you can do so (see "Saving a favourite programme" for more information).

The short cut buttons have different functions in the other menus. Where this is the case, an arrow ▼ will appear in the display above the short cut button, together with a description of its function .

Programme selection

There are two ways of selecting a programme:

- Option 1: Select *Programme selection* from the display and press the multi-function selector.
- Option 2: Press short cut button , , or . This will automatically take you into the main menu for that programme.

Programme selection menu



You can use the multi-function selector to select any programme. The highlighting will move up or down depending on the direction the multi-function selector is turned in.

The ▼▲ arrows on the right of the display, indicate further options.

Pressing the multi-function selector takes you to the main menu of the programme selected.

Wash programme main menu

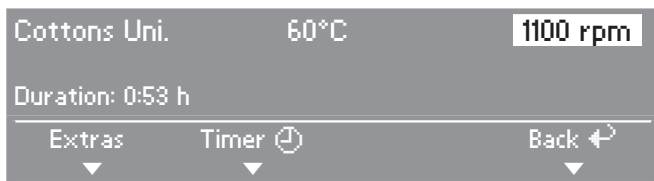

Turn the multi-function selector to highlight programme, temperature or spin speed. Pressing the multi-function selector selects the highlighted option and opens the relevant sub-menu.

The sub-menus *Extras* and *Timer* can be accessed by pressing the short cut button directly below them.

To go back to the entry menu press short cut button 4 below the word *Back*.

Alternatively, you can also highlight and confirm all options by just using the multi-function selector.

Settings menu

The *Settings* menu is used for altering standard settings. See the separate booklet supplied with the machine for further information on how to alter settings.

Operating the machine

Operating a wash-salon machine

The entry menu will vary depending on the *Control* setting selected.

The machine is operated either with the short cut buttons , , , or the multi-function selector.

WS shortcut keys, basic

1	Cottons Uni.	60°C
2	Minimum iron	40°C
3	Delicates	40°C
4	Woollens 	30°C

4 programmes are available to choose from. To specify which programmes are available go to the *Settings/Supervisor level* menu.

WS shortcut keys + Logo



12 programmes are available to choose from. To specify which programmes are available go to the *Settings/Supervisor level* menu.

1. Sort the laundry

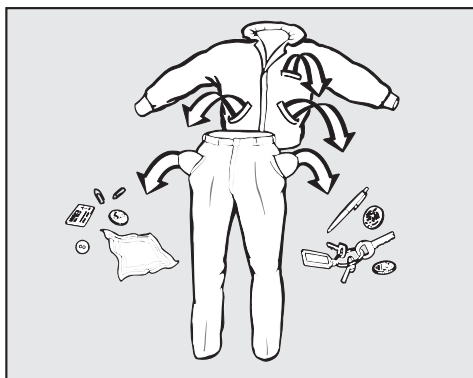

- Empty all pockets.

⚠ Foreign objects (e.g. nails, coins, paper clips, etc.) can cause damage to textiles and to components in the machine.

Removing marks

- Badly soiled areas, stains etc. should be cleaned as soon as possible, preferably whilst still fresh. Spillages should be carefully dabbed off using a soft, colourfast cloth. Do not rub!

Badly soiled areas can be pre-treated with liquid detergent, stain removers etc. first, following the manufacturer's instructions. With particularly stubborn stains ask your dry cleaner for advice.

⚠ Do not use solvent-based cleaning agents in this machine.

Sorting laundry

- Sort the laundry by colour and by care label. Most garments have a textile care label in the collar or side seam.

Dark textiles often contain excess dye and should be washed separately several times before being included in a mixed load. Always wash whites and coloureds separately.

- Curtains: Remove lead weights first or place in a laundry bag.
- Underwiring and collar stiffeners: Any loose wiring in bras, shirt collar stiffeners, etc. should be removed or sewn in.
- Knitted garments, trousers and jeans, T-shirts and sweat shirts: Turn inside out, if recommended by the manufacturer.
- Close any zips, fasten hooks and eyes etc before washing.
- Fasten duvet covers etc. to prevent small items from being rolled up inside them.
- See the separate booklet supplied with the machine for further tips.

Do not wash any items in this machine which are specified by the manufacturer as **not washable** on the care label. (☒ symbol)
Items suitable for professional wet cleaning (Ⓜ garment care label symbol) may be washed in this machine.

Tips

2. Load the drum

- Switch the machine off with the ① On/Off button.
- To open the drum door pull on the handle.

Do not use force as it is fitted with a safety device to prevent it being opened by mistake. Forcing the door handle can cause damage to the locking mechanism (see "Problem solving guide, The door will not open").

- Unfold the laundry and load loosely into the drum. Mixing both large and small items gives better wash results and also helps distribute the load evenly during spinning.

The most efficient use of energy and water is achieved when a full load is washed. However, do not overload as this causes creases and reduces cleaning efficiency.

- Close the drum door. Press the door firmly to shut it and then lock the handle in position. Do not slam the drum door.





 Make sure that no items are caught between the door and the drum.



3. Select a programme





- Select the most appropriate programme for the load being washed.





See the separate booklet supplied with the machine for an overview of which programmes are available.



Garment care label symbols

Washing	
The figure quoted in the bucket is the maximum temperature the garment can be washed at. The number of bars under the symbol indicate the level of agitation permitted.	
	No bar under the symbol: = normal agitation
	One bar under the symbol: = reduced agitation
	Two bars under the symbol: = much reduced agitation
	Hand wash (if no temperature is specified use the lowest temperature or cold)
	Do not wash

Drying	
The number of dots indicates the drying temperature	
	Normal temperature
	Low temperature
	Do not tumble dry

Ironing	
The number of dots indicates the ironing temperature	
	Hot iron (max sole plate temp. approx. 200°C)
	Medium hot iron (max sole plate temp. approx. 150°C)
	Cool iron (max sole plate temp. approx. 110°C). Do not steam iron garments carrying this symbol.
	Do not iron

Professional cleaning	
	Dry clean only. The letters indicate the type of cleaning agent required.
	
	Professional Wet Clean only
	Do not dry clean

Bleaching	
	Any oxidising bleaching agent can be used
	Only use an oxygen based bleach or a non-chlorine bleach
	Do not bleach

Short instructions

 It is very important to read both the "Tips" and "Garment care label symbols" sections before proceeding.

1 Sort the laundry

2 Load the drum

- Switch on the machine.

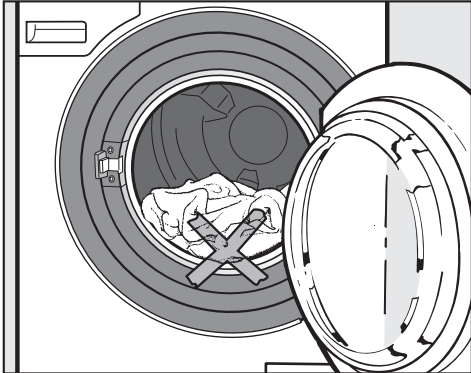

 Make sure that no items are caught between the door and the drum.

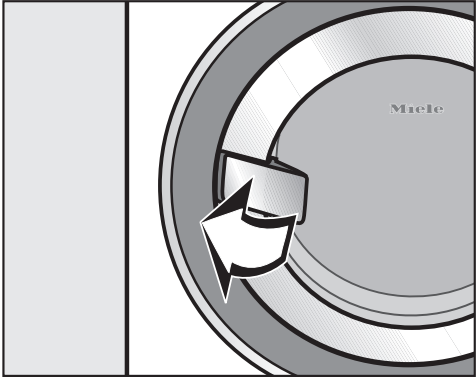

- Open the drum door.



- Unfold the laundry and load loosely into the drum.

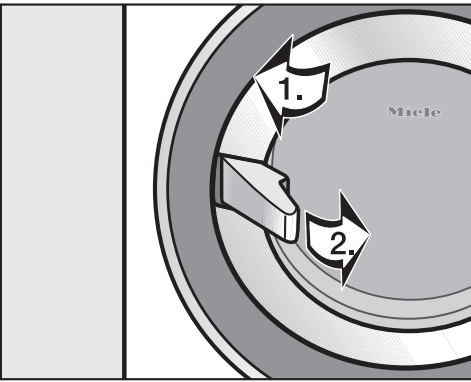

- Close the drum door.
 1. Push the door shut.
 2. Then lock the handle in position.

③ Select a programme

Programme descriptions

- See the separate booklet supplied with the machine for an overview of which programmes are available.

You can select a programme either by:

- using the appropriate short cut button to select one of the four programmes listed in the display ("favourites"), or

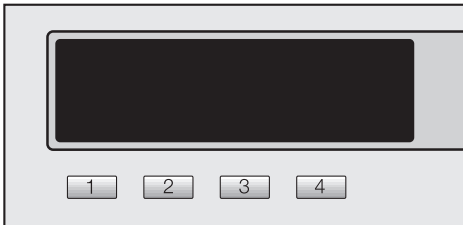

- you can select one from the *Programme selection* menu.

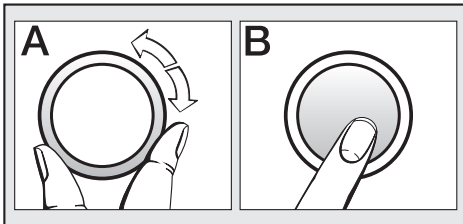

- If required, you can then select any Extras and/or *Timer* for Delay start from the relevant sub-menu.

Payment system

If your machine is connected to a payment system, the amount of payment required will appear in the display.

If a programme is cancelled after it has started you can lose your credit (depending on how the machine was set up).

Short instructions

4 Add detergent

Take the level of soiling and water hardness into account.

Too little detergent results in:

- Laundry not getting properly clean, and with time may become grey and hard to the touch.
- Greasy particles clinging to laundry.
- Limescale deposits on the heater elements.

Too much detergent results in:

- Excessive foam which causes a low level of agitation and poor wash, rinse and spin results.
- A burden to the environment.

See "Detergent" for further information.

This machine is set up for connection to an external dispensing system for dispensing liquid agents (see "Detergent - External dispensing system").

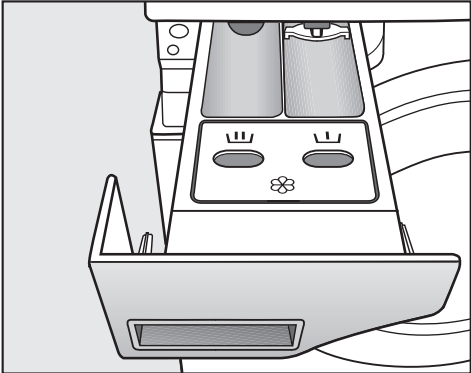

- Pull out the detergent drawer and add detergent to the compartments as follows:

- ☰ = Detergent for the pre-wash
- ☰ = Detergent for the main wash
- ⊗ = Fabric conditioner, liquid starch or proofing agent

- Close the detergent drawer.

The detergent drawer must not be opened during a programme. It must remain closed whilst the machine is in use.

The ⊗ compartment is not used during Disinfection programmes. Do not put anything in the ⊗ compartment.

5 Start the programme

The *Start* button will flash as soon as a programme can be started.

- Press the *Start* button.

The Start button will now light up constantly.

The estimated programme duration will appear in the display. This will count down in one minute steps. During the first 10 minutes the machine measures how much water is being absorbed by the laundry. The programme duration may be shorter depending on this absorbency rate.

The programme sequence is also shown in the display. The machine lets you know which section of the programme has been reached.

Once washing is in progress, you can press the following short cut buttons:

- Button **[1]** *Extras* can be used to select or de-select extras.
- Button **[2]** *Timer* can be used to call up the current time of day and to see the estimated end time of the programme.
- Button **[4]** *Cancel* cancels the current programme. The suds are pumped away immediately.

6 Unload the drum

Finish will appear in the display.

- Open the drum door.
- Remove the laundry.

Check that all items have been removed from the drum. Items left in the drum could discolour other items in the next wash or become discoloured themselves.

- Close the drum door. Otherwise there is the danger of objects being placed inadvertently in the drum. If these remained unnoticed and were washed in the next load, they could damage the laundry.
- Switch the machine off using the *On/Off* button.

Selecting a programme

Selecting/changing a programme

Entry menu

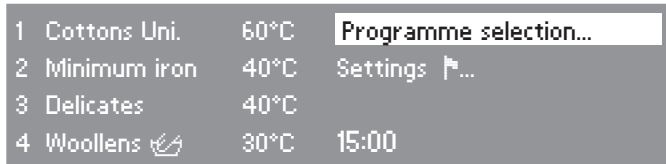

- Press short cut button .

Main menu

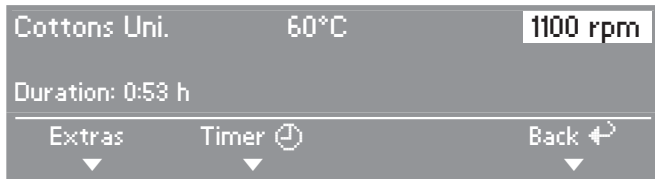

- Using the multi-function selector you can then highlight the following options in the display: Programme, Temperature or Spin speed and confirm your selection by pressing the multi-function selector.

Depending on the option highlighted, the following will be displayed:

– Programme selection



- Use the multi-function selector to select the programme you want and confirm your selection. The main menu will reappear.

Selecting a programme

Note: If you do not make a selection in the sub-menu within approx. 15 seconds, the display will revert to the main menu.

– Temperature selection

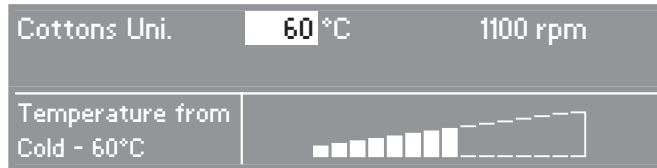

- Use the multi-function selector to select the temperature you want and confirm your selection. The main menu will reappear.

– Spin speed selection



- Use the multi-function selector to select the spin speed you want and confirm your selection. The main menu will reappear.

Select an Extra option(s)

- Press short cut button . This opens the *Extras* sub-menu.

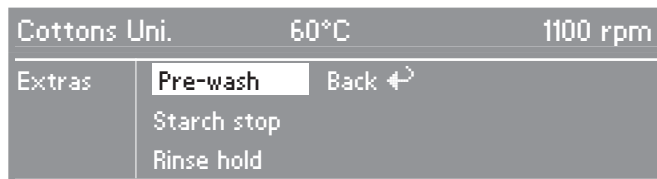

- Use the multi-function selector to select the Extra you want and confirm your selection. The main menu will reappear. Repeat the process if you want to select another extra. See "Extras" for more information.

Selecting a programme

Saving a favourite programme

You can programme the short cut buttons to call up the four wash programmes you use most frequently. The *Save* option must be activated via the *Settings/Supervisor level* menu before the short cut buttons can be programmed.



- Press short cut button **3**.

Selecting a short cut button

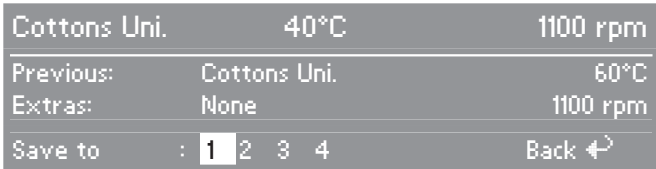

- Use the multi-function selector to select the number you want to save the programme to, and confirm your selection. Your settings have now been saved and the favourite programme will appear in the entry menu.

Repeat the procedure if you want to customise other favourite programmes, and save them to short cut buttons which have not yet been used.

You can use the *Extras* option to augment the basic wash programmes.

To open the Extras sub-menu

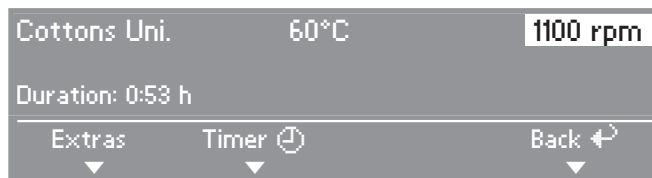

- Press short cut button 1. This opens the *Extras* sub-menu.

Select an Extra option(s)

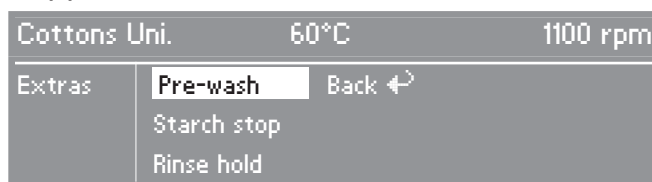

- Use the multi-function selector to select the Extra you want and confirm your selection.
 - Repeat the process if you want to select another Extra.
 - A tick will appear to show that an Extra has been selected.

Pre-wash

For laundry with large amounts of dirt (e.g. dust, sand).

Starch stop

Water is drained out of the machine before the last rinse and the programme stops.

The programme can be continued once starch has been added to the laundry in the drum. For more information about this see "Detergent - Adding starch separately".

Extras

Rinse hold

The laundry is not spun after the last rinse and remains suspended in the final rinse water. This reduces creasing if the laundry is not going to be removed from the drum immediately after the end of the programme.

Intensive*

For heavy soiling or where staining is visible.

The duration of the main wash and of the rinses is increased.

Water plus*

The machine is set at the factory so that the water level in the main wash and rinses will be increased if the *Water plus* extra option is selected.

However, you can select other settings for *Water plus*. See the separate booklet supplied with the machine for details under *Settings/Supervisor level*.

**Intensive* and *Water plus* have to be set in the *Settings/Supervisor level* menu.

Any extras that are available for a programme will be listed in the Extras sub-menu. If an extra is not displayed, it is not available for use with the programme selected.

The timer can be used to select the time you want the programme to finish. The start of a programme can be delayed from 30 minutes up to a maximum of 24 hours,

To open the Timer sub-menu



- Press short cut button 2 below the word Timer. This opens the *Timer* sub-menu.

To select a delay start time

You can enter the end time for a programme in 30 minute stages.



- Use the multi-function selector to select the programme end time and confirm your selection.
The programme end time will be adjusted to the next full or half hour.
The start of the programme will now be delayed in parallel with the programme end time you have selected.

To start the timer

- Press the *Start* button.

The delay start time will be shown counting down in minutes.

To cancel the timer

- Press short cut button 4.

The actual load size can only be determined accurately by the machine once the programme has started. This can cause the finish time for the programme to vary.

Spinning

Maximum final spin speed

The maximum final spin speed will depend on the programme chosen.

You can reduce the final spin speed. However, you cannot select a final spin speed higher than that permitted for the programme selected.

Rinse and interim spin

There is a spin after the main wash and between the rinses. A reduction in the final spin speed will also reduce the interim spin speed.

To omit the final spin (Rinse hold)

- Select *Rinse hold* from the *Extras* sub-menu. The laundry will not be spun and will remain suspended in the final rinse water. This reduces creasing if the laundry is not going to be removed from the drum immediately after the end of the programme.

- To start the final spin:

- The Spin speed is highlighted in the display.

- Start the final spin by pressing the Start button.

- You can alter the spin speed.

- Press the multi-function selector and change the spin speed shown.

- Then confirm your choice. The spin will start straight away.

- To end the programme:

- Press short cut button *Cancel*. The water will drain away.

- Open the drum door.

To omit the spin between rinses and the final spin

- Select *Without spin* from the Spin speed sub-menu. The water will be pumped away after the last rinse cycle.

Changing the programme sequence

Payment system

If a programme is cancelled after it has started you can lose your credit (depending on how the machine was set up).

Interrupting a programme

You can interrupt a programme which is in operation at any time.

- Switch the machine off with the *On/Off* button.

To continue with the same programme:

- Switch the machine back on with the *On/Off* button.
- Confirm the message shown in the display and press the *Start* button.

Cancelling a programme

You can cancel a programme at any time after it has started:

- Press short cut button *Cancel*.

The suds will be pumped away.

- Open the drum door before starting a new programme.

Changing a programme

- After starting a programme you can change the spin speed at any time up until the final spin commences and you can select or deselect the *Starch stop* and *Rinse hold* extras.
- You can change the temperature and select or deselect the *Intensive* and *Water plus* options during the first 5 minutes of a programme.

You will not be able to change or cancel the programme or to open the door if

- a Disinfection programme is running.
- A payment system is connected to the machine (depending on setting it may be possible to cancel a programme. See Settings *Coin mechanism lock*).

Detergent

Detergent dispensing

Please follow the detergent manufacturer's instructions.

Instructions for use and recommended amounts for a full load are given on the detergent packaging.

The right amount to dispense will depend on the following:

- The size of the load
- The soiling level of the load
- The water hardness level.
Check with your local water supplier if you do not know the hardness level in your area.

The water hardness level

Hardness-range	mmol/l	German scale °d
I (soft)	0 - 1.5	0 - 8.4
II (medium)	1.5 - 2.5	8.4 - 14
III (hard)	Above 2.5	Above 14

Water softeners

A water softener can be used to cut down on the use of detergents in hard water areas. Dispense according to the amount specified on the packaging. First add detergent and then the water softener.

Use a quantity of detergent as for soft water.

Washing with several components

If you wash using several components (e.g. special application detergents), we recommend always dispensing the agents into compartment **III** in the following order:

1. Detergent
2. Water softeners
3. Stain remover

This way the agents are distributed more evenly.

Colour run and dye removers/dyes

- Do not use colour run or dye removers in this machine.

Dyes suitable for use in a washing machine can be used. However, please note that the salt used in the dyeing process can cause corrosion to stainless steel components in the machine if you dye frequently. Always observe the manufacturer's instructions carefully.

Fabric conditioners, liquid starch and starch formulations

- Dispense according to the amount specified on the packaging.

Automatic dispensing of fabric conditioner or liquid starch to laundry at the end of a programme

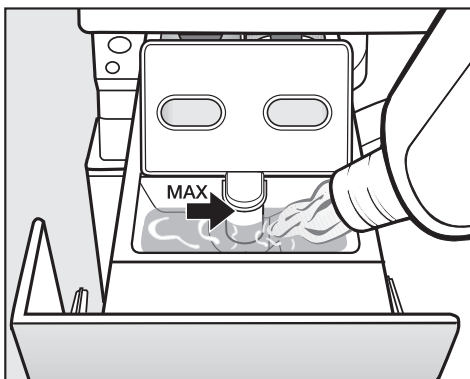

- Add the fabric conditioner or liquid starch to compartment ☼. **Do not exceed the maximum level mark.**

It will be automatically dispensed in the last rinse. At the end of the programme a small amount of water remains in the fabric conditioner compartment ☼.

If starching frequently, thoroughly clean the dispenser compartment, especially the siphon tube and fabric conditioner channel, regularly. See "Cleaning the detergent dispenser drawer". Do not use powder starch formulations or viscious liquid starch in the ☼ compartment as it will clog up. See below.

Adding fabric conditioner or liquid starch separately

- Add fabric conditioner or liquid starch to compartment ☼.
- Select the *Extra rinse* programme.
- Press the *Start* button.

Adding starch separately

- Prepare the starch solution in accordance with manufacturer's instructions on the packaging.
- Add the prepared starch to compartment ☼.
- Select the *Starch* programme.
- Press the *Start* button.

Adding starch separately using Starch stop

- Prepare the starch solution in accordance with manufacturer's instructions on the packaging.
- Before starting a programme select the *Starch stop* extra option. The programme and the "time left" indicator will pause before the last rinse. *Starch stop* will appear in the display.
- Open the drum door and add the prepared starch to the laundry in the drum.
- Close the drum door.
- Select and confirm a spin speed, or
- press the *Start* button.

Detergent

External dispensing system

The machine is fitted with an adapter for an external dispensing system. Up to six dispensing hoses (not supplied) can be connected to the machine. The external pumps are controlled by relays in the machine. Each relay is switched on for 2 minutes at a time.

A separate connection box for electrically controlling the dispensing pumps is required, and must be fitted by a Miele approved service technician.

The relay is controlled as described in the separate booklet supplied with the machine. The containers must be filled with the correct detergent or disinfectant in the order specified.

Empty sensor

When the *Empty sensor* is activated, a message appears in the display to show when an external liquid agent container is empty (see *Settings/Supervisor level* in the separate booklet supplied with the machine).

If a container is empty, the following message will come up in the display before the start of the programme or whilst the programme is running:



A programme that has already been started continues to run until it has finished.

- Press short cut button to delete the message in the display, and refill the container.

If a **Disinfection programme** is running, the following message is displayed:

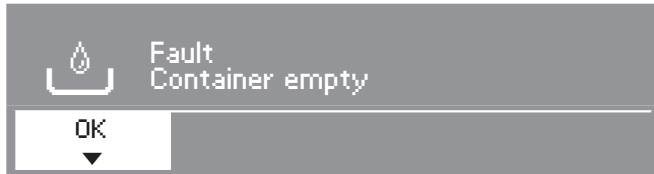

The programme will be cancelled.

- Press short cut button to delete the message in the display, and refill the container.
- Start the programme again.

 If the container is empty for a disinfection programme, you have to assume that **no** disinfection has taken place. Start the programme again.

Cleaning and care

 Disconnect the machine from the mains electricity supply.

Cleaning the machine

 Do not use solvents, abrasive cleaners, glass cleaners or all-purpose cleaning agents. These might damage plastic surfaces and other components because of the chemicals they contain.

Casing and control panel

- Clean the casing and the control panel with a mild non-abrasive detergent or soap and water. Wipe dry with a soft cloth.
- Stainless steel areas can be cleaned using a suitable proprietary stainless-steel cleaning agent following the manufacturer's instructions on the packaging.

 The machine must not be hosed down.

Cleaning the drum, suds container and drainage system

The drum, suds container and drainage system can be cleaned if necessary.

- Start the *Maintenance programme*.
- At the end of the programme check the inner drum and remove any coarse residues.

If you use disinfection programmes on a regular basis, the *Maintenance programme* should be carried out frequently.

Cleaning the detergent dispenser drawer

Remove detergent residues regularly.

There is a yellow lever behind the detergent drawer fascia panel.

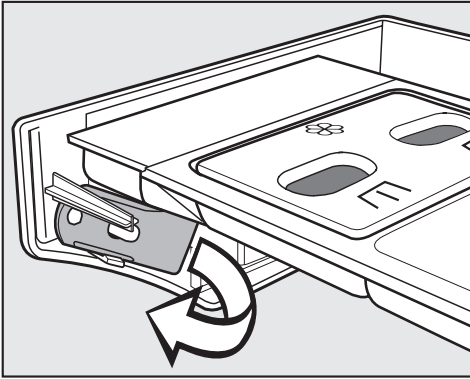

- Remove the lever.

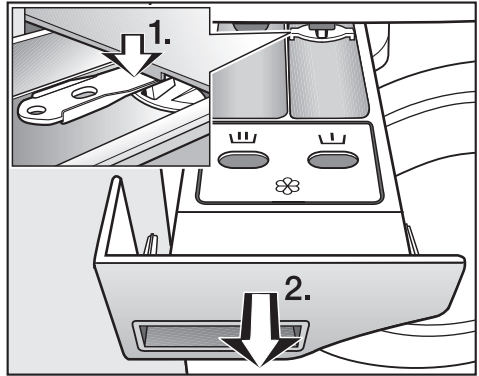

- Pull the detergent drawer out as far it will go.
1. Then press the safety catch down using the lever as illustrated.
 2. Then pull the detergent drawer out.
- Clean the drawer with warm water.

Cleaning and care

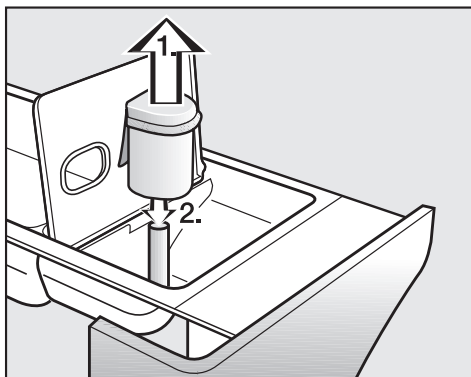

■ Clean the siphon.

1. Remove the siphon from compartment  and rinse under warm running water. Clean the siphon tube in the same way.
2. Replace the siphon.

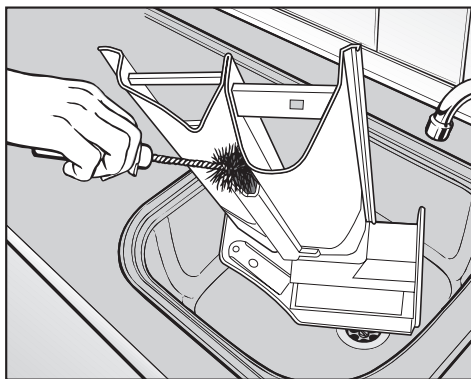

■ Clean the fabric conditioner channel using a brush and warm water.

If starching frequently, thoroughly clean the siphon, the siphon tube and the fabric conditioner channel regularly. A build-up of liquid starch will cause it to get clogged.

Cleaning the detergent dispenser drawer housing

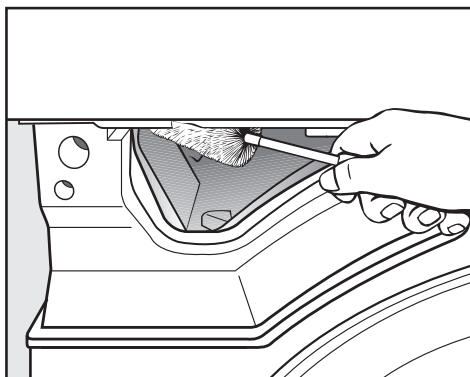

■ Use a bottle brush to remove detergent residues and limescale from the jets inside the detergent dispenser drawer housing.

Cleaning the water inlet filters

The machine has two filters to protect the water inlet valve. These filters should be checked every six months or so, or more often if there are frequent interruptions to the external water supply.

To clean the filter in the inlet hose:

- First turn off the stopcock.
- Unscrew the threaded union connecting the free end of the inlet hose to the stopcock.

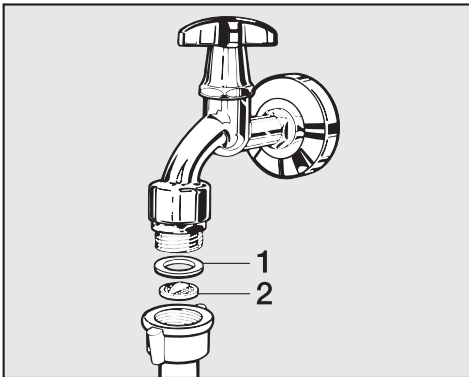

- Remove the rubber seal **1** from the recess.
- Using pointed pliers, take hold of the plastic filter bar **2** and remove.
- Clean the plastic filter.
- Put the filter and seal back in the reverse order and reconnect the hose.

Turn on the stopcock and check the connection is watertight. If water drips out, tighten the connection.

To clean the filter in the water inlet valve:

- Using pliers, carefully loosen the ribbed plastic nut on the inlet valve and unscrew.

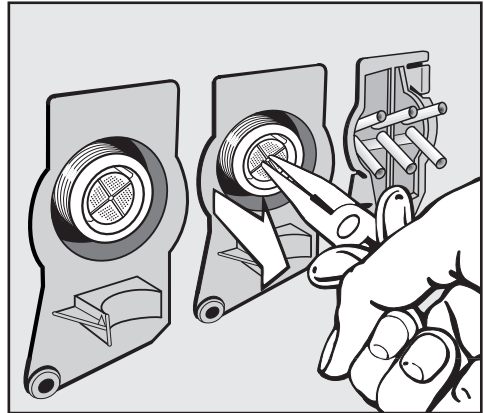

- Use pointed nose pliers to withdraw the plastic filter by the bar (see illustration). Clean, put back and secure.

The two filters **must** be replaced after cleaning.

Problem solving guide

What to do if . . .





With the help of the following notes, minor faults in the performance of this machine, some of which may result from incorrect operation, can be put right without contacting the Service Department.

You should, however, note the following:

 Repair work to electrical appliances should only be carried out by a suitably qualified person in strict accordance with current local and national safety regulations. Repairs and other work by unqualified persons could be dangerous. The manufacturer cannot be held liable for unauthorised work.



The programme does not start

Problem	Possible cause	Remedy
The display remains dark.	There is no power to the machine.	Check whether <ul style="list-style-type: none">– the electricity supply to the machine is switched on.– the fuse or circuit breaker has tripped.
The programme does not start when <i>Spin</i> has been selected.	The machine has not been prepared for using for the first time.	Run the <i>Cottons Universal 60°C</i> programme as described "Commissioning the machine" in the separate booklet supplied with the machine.
The display is dark and the <i>Start</i> button is flashing slowly.	The display has switched off automatically to save energy (Standby mode).	Press one of the short cut buttons. The machine comes out of standby mode.

A fault message appears in the display		
Message	Possible cause	Remedy ①
 <p>Water intake fault Open the stopcock and check the inlet hose.</p>	The water inlet is blocked or restricted.	Check whether <ul style="list-style-type: none"> – the stopcock is opened enough. – the inlet hose is kinked.
	The water pressure is too low.	– Select <i>Low water pressure</i> in the <i>Settings/Supervisor level</i> menu.
 <p>Technical fault</p>	There is a fault.	Start the programme again. If the fault message appears again, contact the Service Department.
 <p>Fault Disinfection temperature not reached</p>	During the disinfection programme the water temperature was not reached.	The machine has not carried out the disinfection cycle correctly. Start the programme again.
 <p>Drain fault Clean the drainage system.</p>	The water outlet is blocked or restricted.	LP version: Clean the drainage system. AV version: Call Service.
 <p>Fill the container or Fault Container empty</p>	One of the external detergent containers is empty.	See "Detergent - Empty sensor".

① To switch off the fault message, press the multi function selector.

Problem solving guide

General problems		
Problem	Possible cause	Remedy
The machine shakes during the spin cycle.	The machine feet are not level.	Level the machine (see "Installation and connection").
The pump makes strange noises.	This is not a fault! These noises occur at the end of a pump sequence as a normal part of the operation.	
Large amounts of detergent residue remain in the detergent dispenser drawer.	The water pressure is too low.	<ul style="list-style-type: none"> – Clean the filters in the water inlets. – It may be useful to select the <i>Water plus</i> extra option.
	Powder detergent used in conjunction with water softeners tends to become sticky.	In future, add washing powder into the dispenser drawer first, and then add the water softener.
Fabric conditioner is not completely dispensed or too much water remains in the  compartment.	The siphon tube is not correctly positioned or is clogged up.	Clean the siphon, (see "Cleaning and care - Cleaning the detergent dispenser drawer").
The display is in a different language.	A different language has been selected in "Settings  "Language  .	Set the language you want. The flag symbol will guide you.

An unsatisfactory wash result		
Problem	Possible cause	Remedy
Liquid detergent does not give the required result.	Liquid detergents usually contain no bleaching agents. They do not remove fruit, coffee and tea stains.	<ul style="list-style-type: none"> – Use a general purpose detergent containing a bleaching agent. – Pour stain removers into compartment  of the dispenser drawer and liquid detergent into a dispenser ball. – Never put stain removers and liquid detergent together in the dispenser drawer.
Grey, greasy particles cling to washed laundry.	Insufficient amounts of detergent were used to break down the particles of grease in heavily soiled laundry.	<ul style="list-style-type: none"> – Use more detergent. – Before washing the next load run a Cottons 95°C programme with powder detergent but without a load.
White residues which look like powder detergent are seen on dark textiles after washing.	The detergent contained compounds (zeolites) to aid water softening which are not soluble in water. They have ended up on the laundry.	<ul style="list-style-type: none"> – Try and brush off the residues with a soft brush once the laundry is dry. – Wash dark textiles using a detergent which contains no zeolites. Liquid detergents usually contain no zeolites.
Textiles have particularly greasy soiling.	<ul style="list-style-type: none"> – Select a programme with pre-wash. Use a liquid detergent for the pre-wash and a powder detergent for the main wash. <p>The use of heavy-duty detergent is recommended in the main wash for very heavily soiled work clothing. Consult detergent producers for advice.</p>	

Problem solving guide

The door will not open	
Possible cause	Remedy
The door is locked after a programme has been cancelled.	For safety reasons the drum door cannot be opened if the suds temperature is higher than 50°C. Wait until the machine has cooled down.
The door will not open at the end of a wash programme.	Press against the door handle, switch the machine off and then back on again. Then pull on the door handle again.
There is still water in the drum and the machine is unable to drain.	The drainage system may be blocked. Clean the drainage system as described in the next section.
If you still cannot open the door:	The door handle has a safety device to prevent damage to the lock. Press firmly against the door handle until you clearly hear the safety device engage.

To continue a programme after a power cut	
Possible cause	Remedy
Power cut.	Confirm the message shown in the display by pressing short cut button <input type="checkbox"/> 1 and then press the <i>Start</i> button. The programme will then continue with the next programme stage.
Switch the machine off and then back on again with the <i>On/Off</i> button.	

Opening the drum door in the event of a blocked drain outlet and/or power failure

 Disconnect the machine from the mains electricity supply.

There is a lever behind the detergent drawer fascia panel which opens the access flap to the drain system.

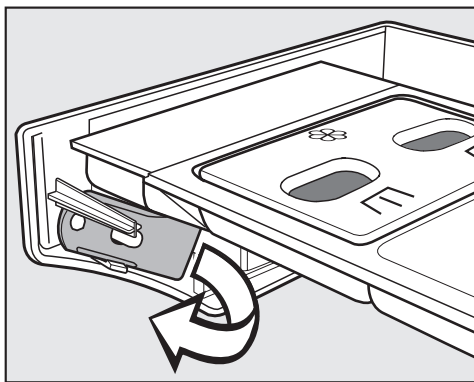

- Remove the lever.

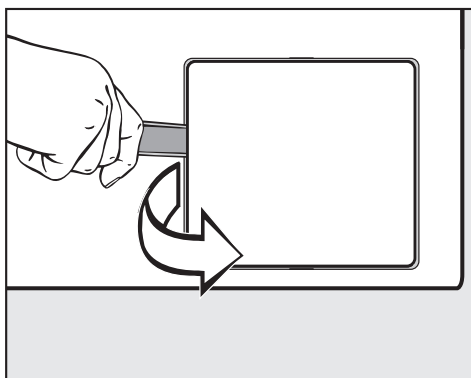

- Use it to open the access flap.

Drain the machine.

If the drain outlet is clogged, a large amount of water will be retained in the machine (**up to 35 litres**).

 Caution: if laundry has been washed at a high temperature, water draining out of the machine will still be hot. Danger of scalding.

... Machines with a drain filter

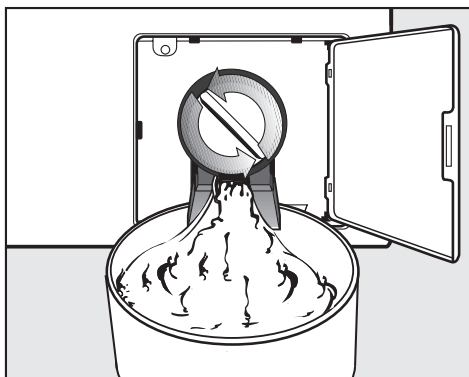

- Place a suitable container under the access flap.

When draining water from the machine, do **not** unscrew the drain filter completely or take it right out.

- Slowly and carefully unscrew the drain filter to let the water out.

If you need to interrupt the flow of water:

- Tighten the drain filter back up again.

Problem solving guide

Once the flow of water ceases:



- Remove the drain filter completely.

Cleaning the drainage system

- Clean the drain filter thoroughly.

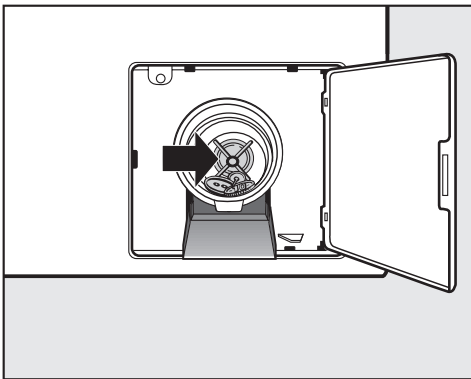

- Remove any foreign objects (e.g. buttons, coins, etc.) and fluff from the filter housing. Turn the impeller by hand to check that it rotates freely.
- Put the drain filter back in place and secure it.

 Make sure the drain filter is securely tightened. Otherwise there is a risk of water leakage during use.

... Machines with a dump valve

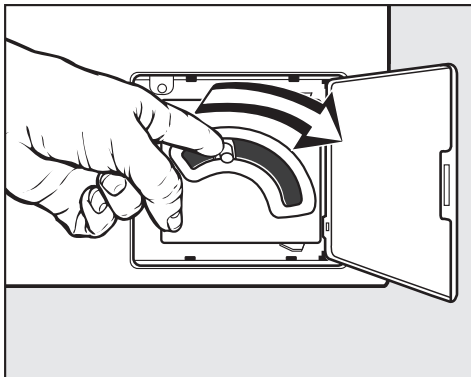

- Push the emergency drain lever downwards (see illustration) and hold until no more water runs out.

Opening the drum door

 Always make sure that the drum is stationary before reaching into the machine to remove laundry. Reaching into a moving drum is extremely dangerous.

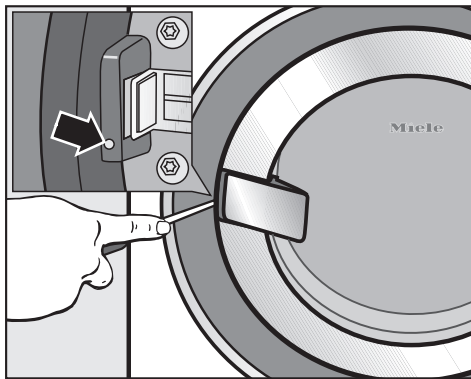

- Insert a suitable screwdriver (approx. 4 mm blade) into the opening next to the door lock and use it to release the catch. Turning it slightly in an anti-clockwise direction should release the door.
- Open the door with the handle.

 Do not use force to open it.

After sales service

Repairs

In the event of any faults which you cannot remedy yourself, or if the machine is under guarantee, please contact:

- Your Miele dealer, or
- the Miele Service Department (see back cover for contact details).

When contacting your Dealer or the Service Department, please quote the model and serial number of your machine, both of which are shown on the data plate visible above the porthole glass when the drum door is open.

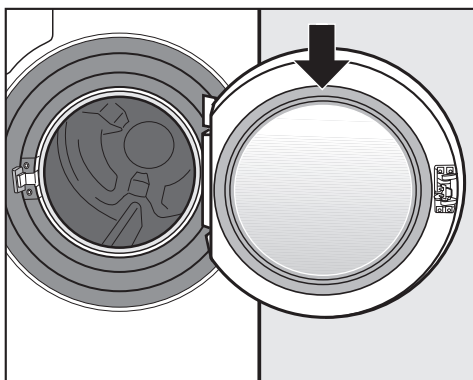

A charge will be made for service call-outs where the problem could have been resolved as described in these instructions.

PC / Optical interface

The indicator or check light marked **PC** on the fascia panel is the interface used by Miele service technicians during servicing work for testing purposes and for updating the machine's programme data.

Optional accessories

Optional accessories for this machine are available from your Miele Dealer or from the Miele Spare Parts Department.

Front view

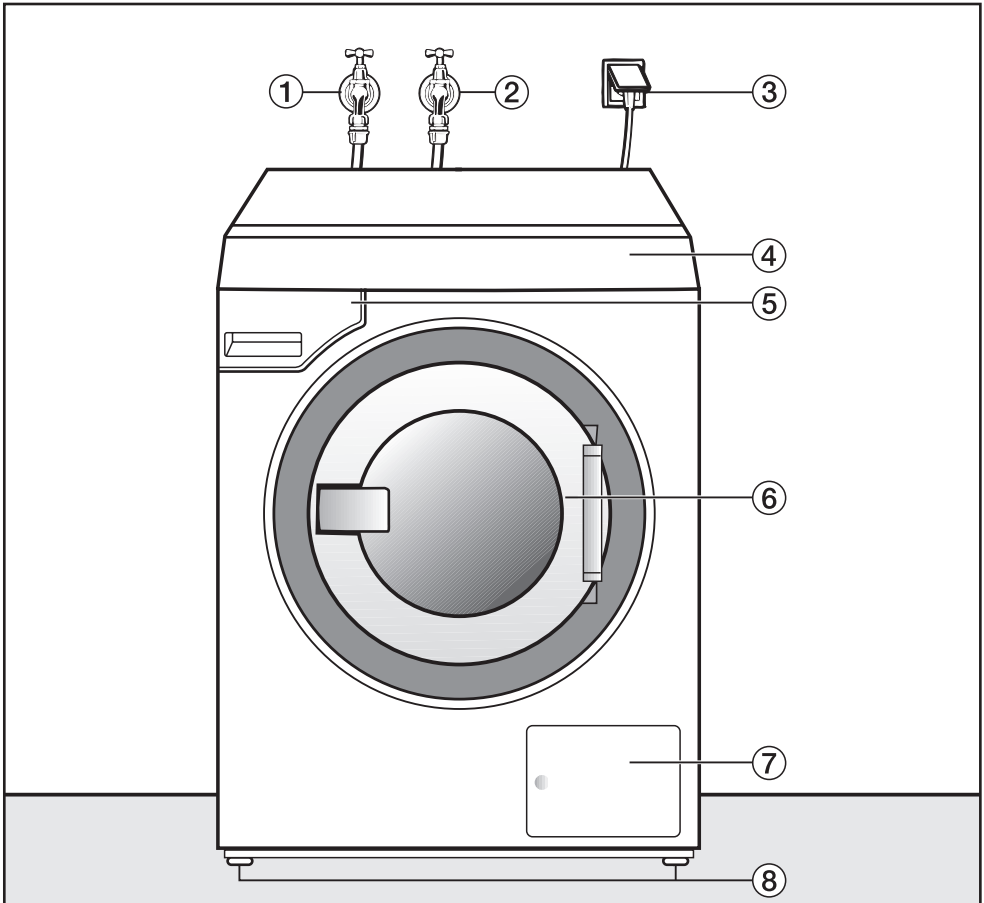

① Inlet hose (cold water)

② Inlet hose (hot water)

③ Mains connection cable

④ Control panel

⑤ Detergent dispenser drawer

⑥ Door with handle

⑦ Access to drain filter, drain pump or
dump valve

⑧ Height adjustable feet

Installation

Rear view

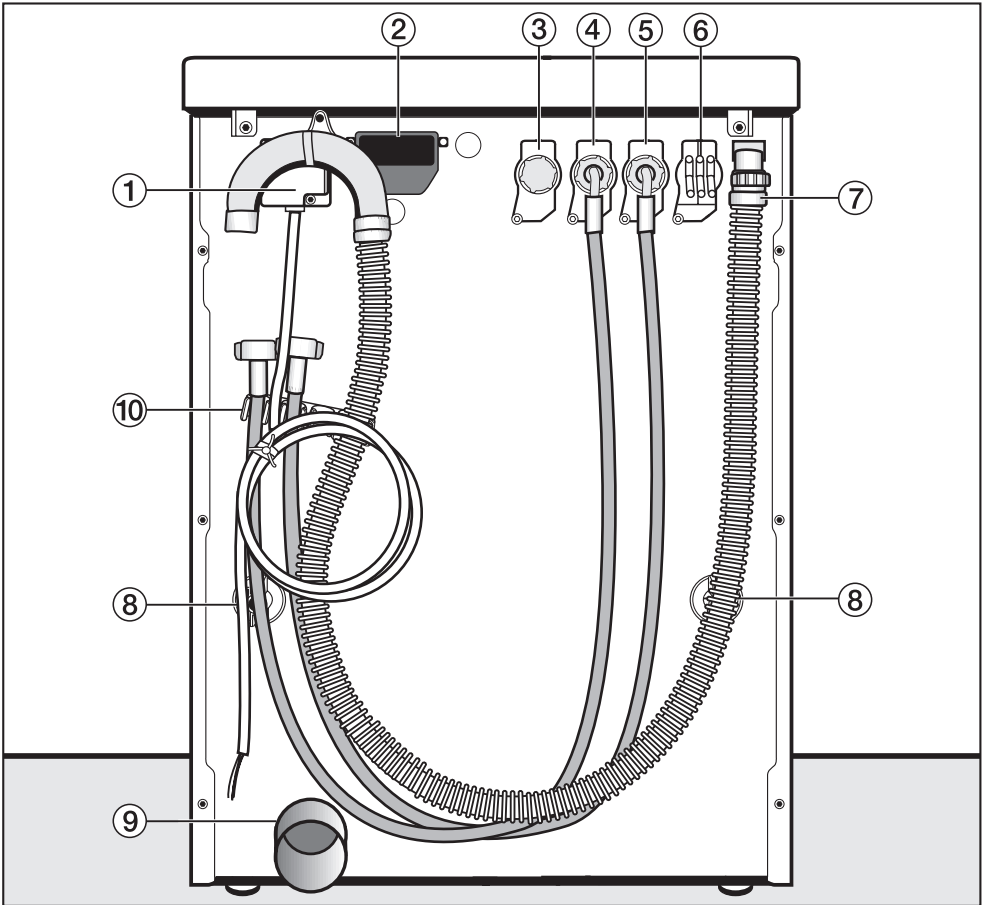

- ① Mains connection cable
- ② Installation shaft for communication module
- ③ Valve for recycled water
- ④ Inlet hose (hot water)
- ⑤ Inlet hose (cold water)
- ⑥ Adapter for external dispensing system
- ⑦ Drain hose (for machines with drain pump)
- ⑧ Transit bars
- ⑨ Drain pipe for machines with dump valve
- ⑩ Restraining clip for inlet hose and drain hose

Installation

Side view

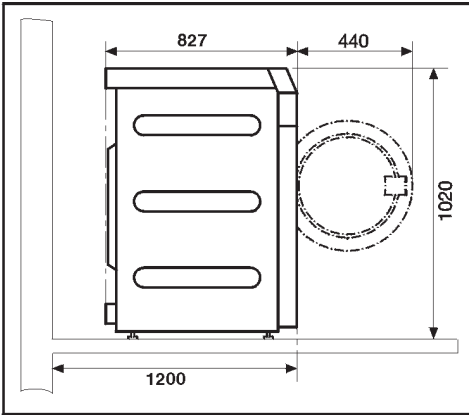

Bird's eye view

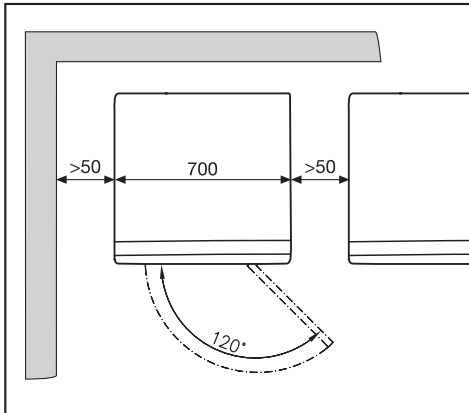

Installing the machine

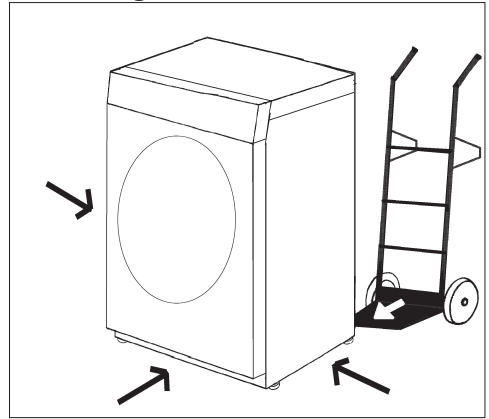

- Transport the machine to its installation site.

⚠ Ensure the machine is stable during transportation.

⚠ **Do not** lift the machine by the drum door.

⚠ This machine is not suitable for building under a worktop.

Installation

Installation on a raised plinth

The machine can be installed on a steel plinth base (available open or closed) or on a concrete plinth.

 If the machine is installed on an on-site concrete or brick plinth, it **must** be secured using the clamps supplied with the machine. Otherwise there is the danger of the machine moving and falling off the plinth during spinning.

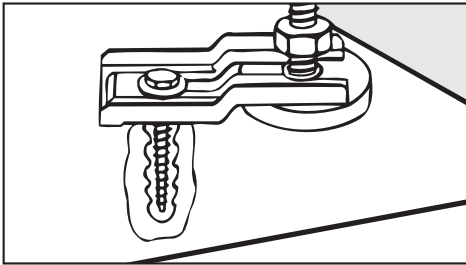

- Secure the front feet of the machine with the clamps supplied.
- Follow the fitting instructions supplied.

Payment system

This machine can be fitted with a payment system.*

The payment system can be set up by the Miele technician or authorised dealer when the machine is commissioned.

Coins / tokens must be removed from the payment system regularly, otherwise it will become blocked.

* These can be obtained from the Miele Spare Parts department.

Installation surface

 Do not install the machine near or directly above an open gully or floor drain. Moisture from these can penetrate the machine and damage the electric components.

 Ensure that the machine feet and the floor are dry to prevent the machine from slipping during the spin cycle.

A concrete floor is the most suitable installation surface for a washing machine, being far less prone to vibration during the spin cycle than wooden floorboards or a carpeted surface.

- The machine must be level and securely positioned.
- To avoid vibrations during spinning, the machine should not be installed on soft floor coverings.

If installing on a wooden joist floor:

- We recommend a plywood base (at least 69 x 87 x 3 cm). The base should span several joists and be bolted to the joists and not only to the floorboards. Check for the presence of pipes and cables first.

If possible, install the machine in a corner, as this is usually the most stable part of the floor.

Removing the transit bars

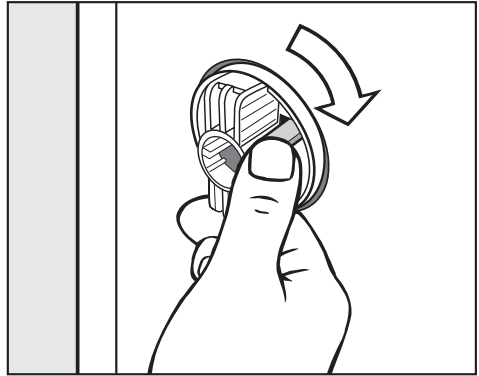

- Release the catch and turn the left hand transit bar clockwise by 90°.

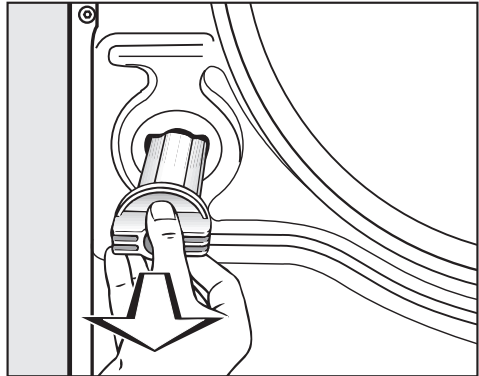

- Then withdraw the transit bar.

Installation

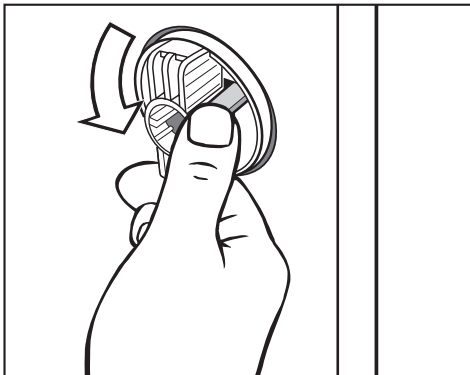

- Release the catch and turn the right hand transit bar anti-clockwise by 90°.

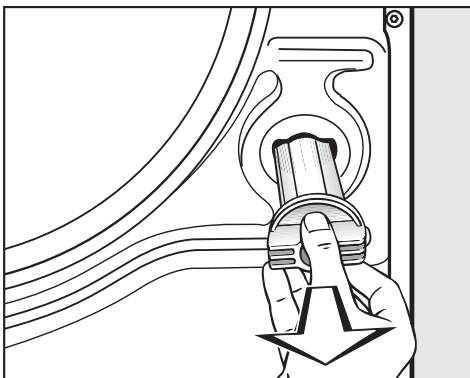

- Then withdraw the transit bar.

⚠ To avoid the risk of injury the holes for the transit bars must be covered after the transit bars have been removed.

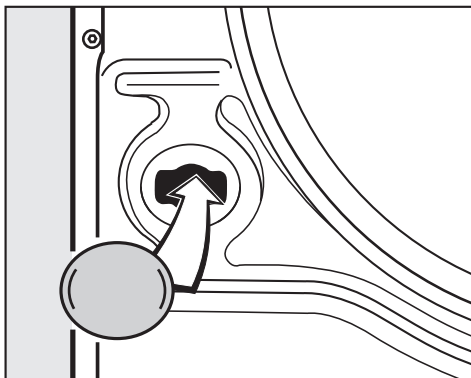

- Plug the holes with the plastic caps supplied.

⚠ The machine must not be moved without the transit bars in place. Store them as shown or keep them in a safe place for future use. They must be re-fitted if the machine is to be moved again (e.g. when moving house).

⚠ When moving the machine make sure it is stable.

Re-fitting the transit bars

Re-fitting is carried out by reversing the procedure.

Levelling the machine

Ensure that the machine feet and the floor are dry to prevent the machine from slipping during the spin cycle.

 The machine must stand perfectly level on all four feet to ensure safe and proper operation.

Incorrect installation may increase electricity and water consumption and may cause the machine to move about.

Screwing out and adjusting the feet

The four adjustable screw feet are used to level the machine. All four feet are screwed in when the machine is delivered.

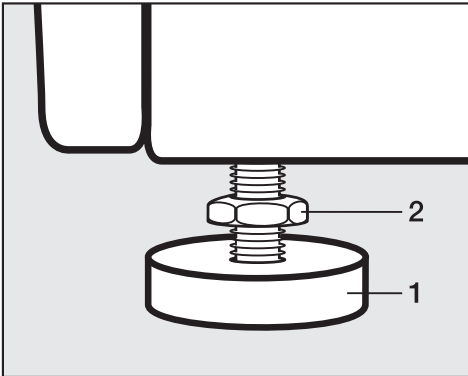

- Using the spanner supplied, turn counter nut **2** in a clockwise direction. Then turn counter nut **2** together with foot **1** to unscrew.

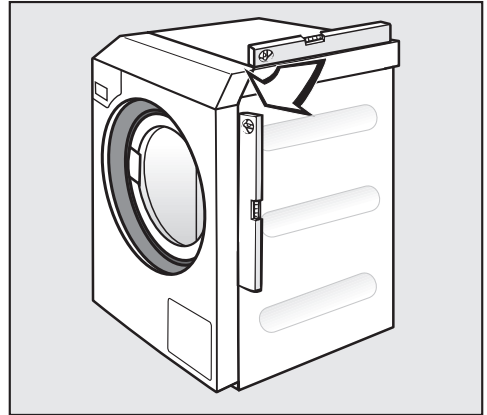

- Use a spirit level to check the machine is standing level.
- Hold foot **1** securely with a pipe wrench. Turn counter nut **2** again using the spanner supplied until it sits firmly up against the housing.

 All four counter nuts must sit firmly up against the housing. Please also check this for the feet which did not need adjustment. Otherwise there is the danger of the machine moving about.

Installation

Plumbing

This machine is approved for all UK applications as suitable for category 5. The product is listed in the WRAS regulations advisory scheme directory and is suitable for direct connection to mains drinking water. No special plumbing arrangements e.g. break tanks are required.

Three Water Council approved double check valves are supplied in the accessories pack provided with this machine. They should be fitted in between the stopcocks and the water inlet hoses.

The machine is built in accordance with current DIN standards and must be connected to a mains water supply in accordance with local and national safety regulations. It can be connected with out a non-return valve if national regulations permit

The machine is designed to operate with a flow pressure of between 1 and 10 bar (100 kPa and 1,000 kPa). At higher water pressures it is essential to fit a reducer valve.

Connection to the water supply should be carried out by a qualified plumber and should incorporate a stopcock with a 3/4" thread. The stopcock should be fitted by a qualified plumber.

The machine is supplied as standard with two hoses, for connection to a hot and cold water supply.

Connection to the cold water supply

The cold water inlet hose (blue stripes) must be connected to the on-site cold water supply via a 3/4" threaded union. It is **not** suitable for connection to a hot water supply.

 The connection point is subject to mains water pressure. Turn on the stopcock slowly and check for leaks. Correct the position of the washer and union if appropriate.

Maintenance and care

Only use a genuine Miele hose should you ever need a replacement. Miele hoses are tested to withstand pressure of at least 70 bar (7,000 kPa).

In order to protect the water inlet valve, the two dirt filters - one in the open end of the inlet hose, one at the inlet point in the machine - must not be removed.

Extension hose

Longer hoses 2.5 or 4.0 m in length are available from your Miele dealer or the Miele Spare Parts Department as optional extras.

Connection to the hot water supply

To keep electricity consumption costs down this machine can be connected to a (ring) piped hot water supply, max. temperature 70°C. It is not economical to run it from an individual hot water supply if it is not in continuous use, as the water in the supply pipes cools down and more energy would be required to reheat the water. For hot water connection the same conditions apply as for cold water connection.

The inlet hose with the red stripes (hot water hose) is connected to the stopcock.

For operational reasons the machine must not be connected to hot water only.

If the machine is **not** connected to a hot water supply, the hot water inlet hose must be disconnected and the water settings for the *main wash*, *pre-wash* and *rinses* must be reprogrammed.

- Select the cold option in the *Settings menu/Supervisor level/menu*.

The programme durations may be longer.

- Disconnect the hot water hose (hot water - red stripes)
- Plug the inlet hole with the blanking cap supplied.

Recycled water connection

This machine can be connected to a recycled water supply.

- Unscrew the blanking cap from the recycled water valve.
- Connect the additional inlet hose to this valve.

The *main wash* and *rinses* water settings must then be set as appropriate.

- Go to *Settings menu/Supervisor level* menu and select the *Recycled water* option.

Connection to a very hot water supply

It is possible to connect the machine to a very hot water supply, 70°C to a maximum of 85°C. A special inlet hose is required. The machine must also be reprogrammed by a Miele service technician or Miele authorised service dealer.

Installation

Water drainage

Dump valve version

A motorised dump valve is used to drain the machine. A DN 70 angle connector can be used for draining the machine via an on-site gully (with odour trap). N.B. If not supplied with the machine, an angle connector is available to order from Miele.

Machines with a drain pump

The machine drains via a drain pump with a delivery head of 1 metre*. The drain hose must not be kinked as this restricts drainage. The swivel elbow at the end of the hose can be turned in either direction, or can be detached if required, with a sharp twist and pull.

Drain hose connection:

1. Connected securely to a plastic drain pipe with a rubber nipple.
There is no need to use a non-return valve.
2. Connected securely to a standpipe.
3. Connected securely to a floor gully.

If required, the drain hose can be extended to a length of 5 m. The necessary parts can be purchased from the Miele Spare Parts Department or your Miele dealer.

* For a delivery head of more than 1 m (up to a max. of 1.6 m) a second duo-drain pump is available with the corresponding kit from the Miele Spare Parts Department or your Miele Dealer.

Electrical connection

This machine is supplied with a connection cable without a plug for connection to a suitable connection socket or isolator switch.

 The voltage, rated load and fuse rating are given on the data plate. Please ensure these match the site mains supply.

This machine must be connected to the electricity supply in accordance with local and national safety regulations (BS 7671 in the UK).

Connection to the electricity supply must only be carried out by a suitably qualified and competent person.

Connection should be made via a suitable connection socket or isolator which complies with local and national safety regulations and which is easily accessible for disconnecting the machine from the electrical supply. Provision must be made on site to switch off all poles. Switches with a minimum all-pole contact gap greater than 3 mm are suitable for isolating the machine. These include circuit breakers, fuses and relays (IEC/EN 60947).

 If the machine is disconnected from the electricity supply ensure adequate measures are taken to ensure that the machine cannot be reconnected to the electricity supply until all work has been carried out.

Should the connection cable require replacing or changes be necessary in the electrical installation including checking and/or replacing the fuse please make sure this is done by an approved electrician to ensure compliance with all local and national electrical safety requirements.

For extra safety, it is advisable to protect the machine with a suitable residual current device (RCD).

**WARNING:
THIS APPLIANCE
MUST BE EARTHED**

Height	1020 mm
Width	700 mm
Depth	827 mm
Depth with door open	1267 mm
Weight	148 kg
Max. load bearing in operation	2750 Newton (ca. 275kg)
Capacity	10.0 kg dry laundry
Voltage	See data plate
Connected load	See data plate
Fuse rating	See data plate
Emission sound pressure level in accordance with EN ISO 11204/11203	< 70 dB re 20 µPa
Minimum water flow pressure	100 kPa (1 bar)
Maximum water flow pressure	1,000 kPa (10 bar)
Inlet hose length	1.55 m
Mains connection cable length	1.80 m
Drain pump head max. (drain pump version)	1.00 m
Product safety standard	EN 10472, EN 60335
Test certificates awarded	See data plate

United Kingdom

Miele Co. Ltd.
Fairacres, Marcham Road
Abingdon, Oxon, OX14 1TW
Tel: 0845 365 0555
Fax: 0845 365 0777
Customer Contact Centre Tel: 0845 365 6600
E-mail: info@miele.co.uk
Internet: www.miele.co.uk

Australia

Miele Australia Pty. Ltd.
ABN 96 005 635 398
1 Gilbert Park Drive, Knoxfield, VIC 3180
Tel: (03) 9764 7130, Fax: (03) 9764 7149
Internet: www.miele.com.au

China

Miele (Shanghai) Trading Ltd.
1-3 Floor, No. 82 Shi Men Yi Road
Jing' an District
200040 Shanghai, PRC
Tel: +86 21 6157 3500
Fax: +86 21 6157 3511
E-mail: mieleshanghai@cn.miele.com
Internet: www.miele.cn

Miele (Hong Kong) Limited

41/F - 4101, Manhattan Place
23 Wang Tai Road
Kowloon Bay
Hong Kong
Tel: (852) 2610 1331
Fax: (852) 2610 1013
Email: mielehk@miele.com.hk

India

Miele India Pvt. Ltd.
Ground Floor, Copia Corporate Suites
Plot No. 9, Jasola
New Delhi - 110025
Tel: 011-46 900 000, Fax: 011-46 900 001
E-mail: customercare@miele.in
Internet: www.miele.in

Manufacturer: Germany - Miele & Cie. KG
Carl-Miele-Straße 29, 33332 Gütersloh

Miele

Ireland

Miele Ireland Ltd.
2024 Bianconi Avenue
Citywest Business Campus, Dublin 24
Tel: (01) 461 07 10, Fax: (01) 461 07 97
E-Mail: info@miele.ie, Internet: www.miele.ie

New Zealand

Miele New Zealand Limited
Unit L, 10-20 Sylvia Park Road
Mt. Wellington, 1060, Auckland, NZ
Tel: 0800 264 353, Fax: 0800 463 453
Internet: www.miele.co.nz

Singapore

Miele Southeast Asia
Miele Pte. Ltd.
163 Penang Road
04 - 02/03 Winstland House II
Singapore 238463
Tel: +65 6735 1191, Fax: +65 6735 1161
E-Mail: infosea@miele.com.sg
Internet: www.miele.sg

South Africa

Miele (Pty) Ltd
63 Peter Place, Bryanston 2194
P.O. Box 69434, Bryanston 2021
Tel: +27 (0) 11 548-1900
Fax: +27 (0) 11 548-1935
E-mail: info@miele.co.za
Internet: www.miele.co.za

United Arab Emirates

Miele Appliances Ltd.
P.O. Box 11 47 82
Gold & Diamond Park
Sheikh Zayed Road
Building 6 / Offices Nos. 6-214 to 6-220
Dubai
Tel: +971-4-341 84 44
Fax: +971-4-341 88 52
E-Mail: info@miele.ae
Internet: www.miele.ae